

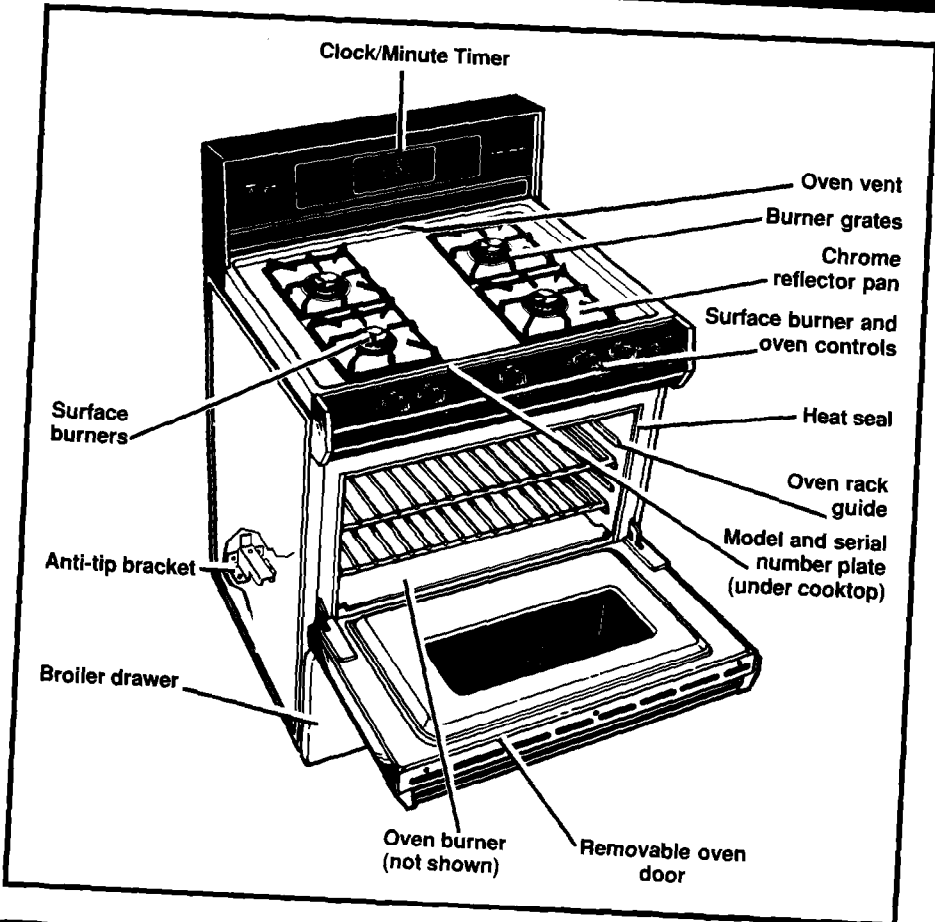

Use & Care Guide



CONTINUOUS-CLEANING GAS RANGE
SF335PEW (Shown) SF3300EW
STANDARD-CLEANING GAS RANGE
SF3100EW

Contents

	Page
Important Safety Instructions	3
Using Your Range	6
Using the surface burners	6
Setting the clock	7
Using the Minute Timer	8
Using the oven control	9
Baking	9
Adjusting the oven temperature control	10
Broiling	11
The oven vent	12
Caring For Your Range	12
Control panel and knobs	13
Surface burner grates and reflector pans	14
Surface burners	15
Removable cooktop	15
Removable oven door	16
Using the standard-cleaning oven .	17
Using the continuous-cleaning oven	17
Cleaning tips	20
The oven light	22
If You Need Service Or Assistance	23
Whirlpool Cooking Product Warranty	28

©1991 Whirlpool Corporation

Thank you for buying a Whirlpool appliance. Please complete and mail the Owner Registration Card provided with this product. Then complete the form below. Have this information ready if you need service or call with a question.

- Copy model and serial numbers from plate (located under cooktop) and purchase date from sales slip.
- Keep this book, the Cooking Guide and sales slip together in a handy place.

Model Number

Serial Number

Purchase Date

Service Company Phone Number

You are responsible for:

- Installing and leveling the range on a floor strong enough to support its weight, and where it is protected from the elements. (See the Installation Instructions.)
- Making sure the range is not used by anyone unable to operate it properly.
- Properly maintaining the range.
- Using the range only for jobs expected of a home range.
- Making sure the range is secured by properly installed anti-tip bracket. The bracket must overlap the range base.

Important Safety Instructions

Gas ranges have been thoroughly tested for safe and efficient operation. However, as with any appliance, there are specific installation and safety precautions which must be followed to ensure safe and satisfactory operation.

⚠ WARNING

To reduce the risk of fire, electrical shock, injury to persons, or damage when using the range, follow basic precautions, including the following:

• FOR YOUR SAFETY •

DO NOT STORE OR USE GASOLINE OR OTHER FLAMMABLE VAPORS AND LIQUIDS IN THE VICINITY OF THIS OR ANY OTHER APPLIANCE. THE FUMES CAN CREATE A FIRE HAZARD OR EXPLOSION.

• FOR YOUR SAFETY •

IF YOU SMELL GAS:

- 1. OPEN WINDOWS.**
- 2. DON'T TOUCH ELECTRICAL SWITCHES.**
- 3. EXTINGUISH ANY OPEN FLAMES.**
- 4. IMMEDIATELY CALL YOUR GAS SUPPLIER.**

IMPROPER INSTALLATION, ADJUSTMENT, ALTERATION, SERVICE OR MAINTENANCE CAN CAUSE INJURY OR PROPERTY DAMAGE. REFER TO THIS MANUAL. FOR ASSISTANCE OR ADDITIONAL INFORMATION CONSULT A QUALIFIED INSTALLER, SERVICE AGENCY, MANUFACTURER (DEALER) OR THE GAS SUPPLIER.

- IMPORTANT -

TO THE INSTALLER: PLEASE LEAVE THIS INSTRUCTION BOOK WITH THE UNIT.

TO THE CONSUMER: PLEASE READ AND KEEP THIS BOOK FOR FUTURE REFERENCE.

Important Safety Instructions Continued

- Install or locate the range only in accordance with the provided Installation Instructions. It is recommended that the range be installed by a qualified installer. The range must be properly connected to the proper gas supply and checked for leaks. The range must also be properly connected to electrical supply and grounded.

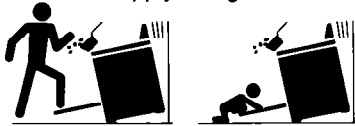

- To reduce the risk of tipping of the appliance, the appliance must be secured by properly installed anti-tip bracket. To check if the bracket is installed properly, shine a flashlight under range toward rear corners and verify that anti-tip bracket is engaged. See Installation Instructions for further details.
- Gas fuels and combustion can result in potential exposure to chemicals known to cause cancer or reproductive harm. For example, benzene is a chemical which is a part of the gas supplied to the range. It is consumed in the flame during combustion. However, exposure to a small amount of benzene is possible if a gas leak occurs. Formaldehyde, carbon monoxide and soot are by-products of incomplete combustion. Properly adjusted burners with a bluish rather than a yellow flame will minimize incomplete combustion.
- Do not operate the range if it is not working properly, or if it has been damaged.
- Do not use the range for warming or heating the room. Persons could be burned or injured, or a fire could start.
- Do not attempt to light the oven burner during a power failure. Personal injury could result.
- Use the range only for its intended use as described in this manual.
- Do not wear loose or hanging garments when using the range. They could ignite if they touch a hot surface burner and you could be burned.
- Do not touch surface burners, areas near burners or interior surfaces of oven. Areas near surface burners and interior surfaces of an oven become hot enough to cause burns. During use, do not touch, or let clothing or other flammable materials contact surface burners, areas near surface burners or interior surfaces of oven. Other surfaces of the range may become hot enough to cause burns; such as, the oven vent opening, the surface near the vent opening, the cooktop, the oven door and window.
- Make sure the utensils you use are large enough to contain food and avoid boil-overs and spill-overs. Heavy splattering or spill-overs left on a range can ignite and burn you. Pan size is especially important in deep fat frying.
- Turn pan handles inward, but not over other surface burners. This will help reduce the chance of burns, igniting of flammable materials, and spills due to bumping of the pan.
- Use only dry potholders. Moist or damp potholders on surface burners may result in burns from steam. Do not let potholder touch surface burners. Do not use a towel or bulky cloth for a potholder. They could catch on fire.

- Check to be sure glass cooking utensils are safe for use on the range. Only certain types of glass, glass-ceramic, ceramic, earthenware or other glazed utensils are suitable for ranges without breaking due to the sudden change in temperature.
- Do not use decorative covers or trivets over the surface burners.
- Do not heat unopened containers. They could explode. The hot contents could cause burns and container particles could cause injury.
- Grease is flammable and should be handled carefully. Let fat cool before attempting to handle it. Do not allow grease to collect around cooktop or in vents. Wipe spill-overs immediately.
- Do not use water on grease fires. Never pick up a flaming pan. Smother flaming pan on range by covering with a well-fitted lid, cookie sheet or flat tray. Flaming grease outside of pan can be extinguished with baking soda or, if available, a multipurpose dry chemical or foam-type extinguisher.
- Never leave surface burners unattended at high heat settings. A boil-over could result and cause smoking and greasy spill-overs that may ignite.
- Make sure surface burners are off when you are finished, and when you are not watching.
- Use care when opening oven door. Let hot air or steam escape before removing or replacing food.
- Always position oven racks in desired location while oven is cool.
- Do not store flammable materials on or near the range. They could explode or burn.
- Do not store things children might want above the range. Children could be burned or injured while climbing on it.
- Do not leave children alone or unattended in area where the range is in use. They should never be allowed to sit or stand on any part of the range. They could be burned or injured.
- Never use a match or other flame to look for a gas leak. Explosion and injury could result.
- Know where your main gas shut off valve is located.
- Keep range vents unobstructed.
- Clean your range regularly. See care and cleaning instructions in this manual.
- Be sure all range parts are cool before cleaning.
- Do not clean door heat seal. It is essential for a good seal. Care should be taken not to rub, damage, or move the seal. Clean only parts recommended in this Use and Care Guide.
- Do not use oven cleaners on continuous-cleaning ovens. No commercial oven cleaner or oven liner protective coating of any kind should be used in or around any part of the oven.
- Do not repair or replace any part of the range unless specifically recommended in this manual. All other servicing should be referred to a qualified technician.
- Disconnect the electrical supply before servicing the range.

- SAVE THESE INSTRUCTIONS -

Using Your Range

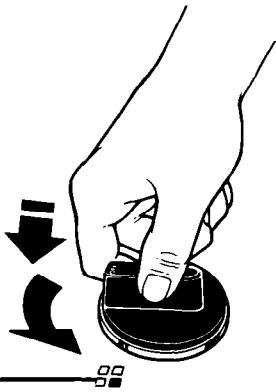

Surface burner marker

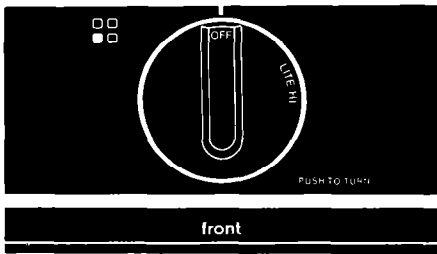

Using the surface burners

Control knobs must be pushed in, then turned to the LITE position. The clicking sound is the ignition sparking.

To stop the clicking sound after the burner lights, turn the control knob back to a desired setting. The control knob can be set anywhere between HI and OFF.

Surface burner markers

The solid dot in the surface burner marker shows which surface burner is turned on by that knob.

Until you get used to the settings, use the following as a guide. For best results, start cooking at the high settings; then turn the control knob down to continue cooking.

Use LITE to light the burner. After the burner lights, turn control back to a desired setting to stop the clicking of the ignition.

Use HI to start foods cooking; to bring liquids to a boil.

Use a medium setting to continue cooking or to fry chicken or pancakes; for gravy, puddings and icing; to cook large amounts of vegetables.

Use a low setting to keep food warm until ready to serve.

NOTE: Do not cook with the control in the LITE position.

In case of a prolonged power failure:

Surface burners can be manually lighted. Hold a lighted match near a burner and turn the control to the LITE position. After the burner lights, turn the control to the desired setting.

⚠ WARNING

Burn, Fire and Explosion Hazard

- **Burner flame should not extend beyond the edge of the cooking utensil. The flame can burn you and cause poor cooking results.**
- **Be sure all control knobs are turned to OFF when you are not cooking. Someone could be burned or a fire could start if a burner is accidentally left ON.**
- **If the flame should go out while cooking, or if there is a strong gas odor, turn the burners OFF. Wait five minutes for the gas odor to disappear, before relighting burner. If gas odor is still present, see safety note on page 3. Failure to follow these precautions could result in explosion or fire.**
- **Do not attempt to light the oven burner during a power failure. Personal injury could result.**

Setting the clock

Push in and turn the Minute Timer Knob to set the Clock.

1. **Push in Minute Timer Knob and turn clockwise** until clock shows the correct time of day.

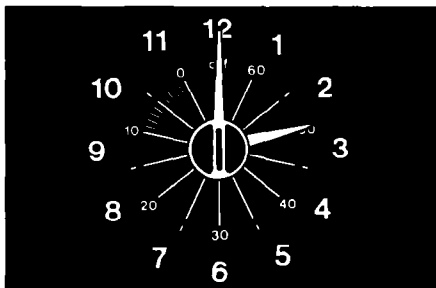

Using Your Range Continued

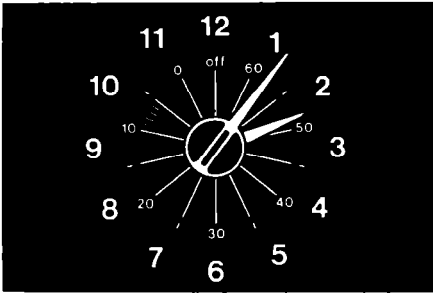

2. Let the Minute Timer Knob pop out. Turn clockwise until Minute Timer hand points to OFF. The clock setting will change if you push in the knob when turning.

Using the Minute Timer

The Minute Timer does not start or stop the oven. It works like a kitchen timer. Set it in minutes up to an hour. You will hear a buzzer when the set time is up.

Do not push in the knob when setting the Minute Timer.

1. Without pushing it in, turn the Minute Timer Knob until the timer hand passes the setting you want.

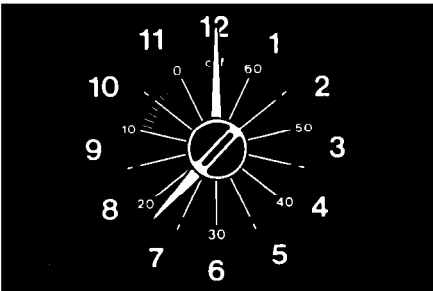

2. Without pushing in, turn the knob back to the setting you want.

When the time is up, a buzzer will sound. To stop the buzzer, turn the Minute Timer hand to OFF.

NOTE: Pushing in and turning the Minute Timer Knob changes the clock setting.

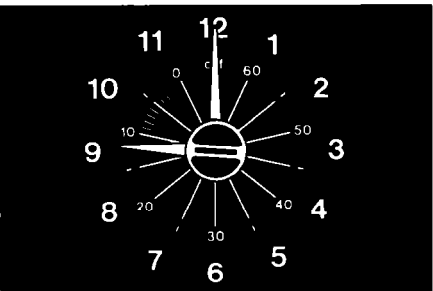

Using the oven control

Baking

1. Position the rack(s) properly **before** turning on the oven. **To change rack position**, pull rack out to stop, raise front edge and lift out.

The rack(s) should be placed so the top of the food will be centered in the oven. Always leave at least 1 1/2 to 2 inches (4-5 cm) between the sides of the pan and the oven walls and other pans. For more information, see the Cooking Guide.

2. Push in and turn the Oven Temperature Control to the baking temperature you want. The oven burner will automatically light in 50–60 seconds.
3. Preheat the oven for 10 minutes. Put food in the oven.

NOTE: Do not place food directly on the oven bottom.

4. During baking, the oven burner will turn on and off to maintain the temperature setting.
5. When baking is done, turn the Oven Temperature Control to OFF.

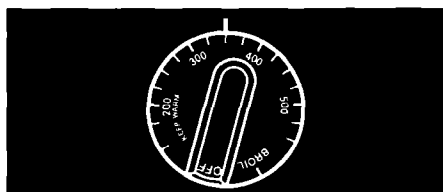

oven temp

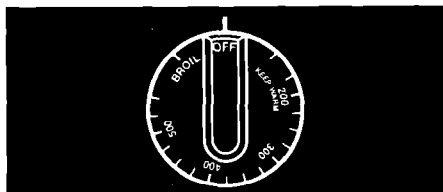

oven temp

Using Your Range Continued

Adjusting the oven temperature control

Does your oven seem hotter or colder than your old oven? The temperature of your old oven may have shifted gradually without you noticing the change. Your new oven is properly adjusted to provide accurate temperatures. But, when compared to your old oven, the new design may give you different results.

If, after using the oven for a period of time, you are not satisfied with the temperature settings, they can be adjusted by following these steps:

1. Turn the Oven Temperature Control Knob to the off position. Pull knob straight off, flip over and turn upside-down so back of knob looks like illustration below.

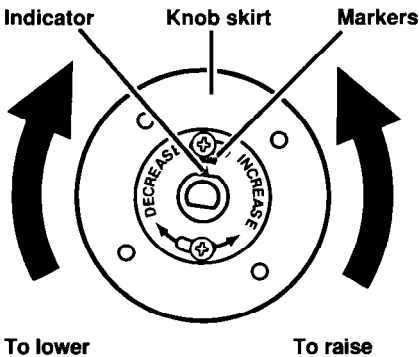
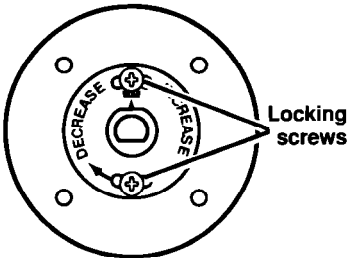
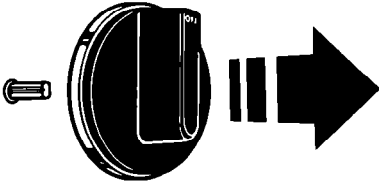

2. Loosen the locking screws. **Note the position of the indicator.**

3. **To lower the temperature**, hold knob handle firmly and turn knob skirt clockwise to move the indicator one marker line to the left. Each line equals about 10°F (5°C).
4. **To raise the temperature**, hold knob handle firmly and turn knob skirt counterclockwise to move the indicator one marker line to the right. Each line equals about 10°F (5°C).

Tighten the locking screws and replace the control knob.

Broiling

The broiler drawer is located below the oven door. **Always broil with the oven door closed.**

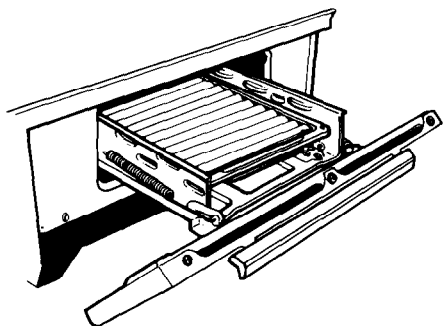

1. Pull the broiler drawer open and tilt the door panel down.

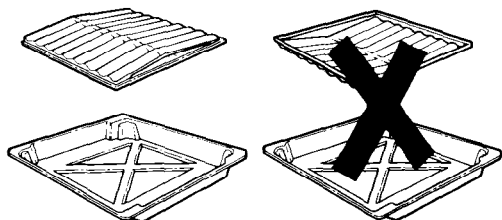

2. Place broiler pan grid so grease can drain down sides into lower part of broiler pan. See picture.
3. Before the broiler is turned on, place food on broiler pan and position the broiler pan at one of the three levels. Refer to a reliable cookbook for broiling chart.

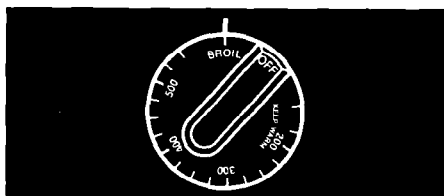

oven temp

4. Push in and turn the Oven Temperature Control to BROIL. The broiler will automatically light in 50–60 seconds.
5. When broiling is done, turn the Oven Temperature Control to OFF.

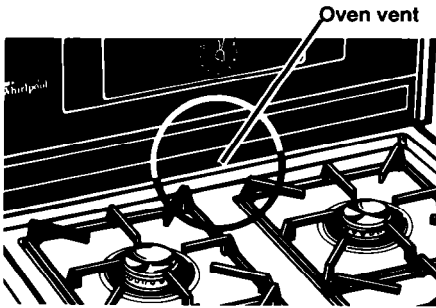

The oven vent

Hot air and moisture escape from the oven through a vent just under the backguard. The vent is needed for air circulation. **Do not block the vent.** Poor baking will result.

⚠ WARNING

Burn Hazard

When the oven is ON, pans and pan handles left near the oven vent can become hot enough to burn the user and to melt plastics. Use potholders to move pans. Never store plastics, paper or other items that could melt or burn near the oven vent, or any of the surface burners.

Caring For Your Range

⚠ WARNING

Burn, Electrical Shock, Fire and Explosion Hazard

- **Make sure all controls are OFF and the range is cool before cleaning.**
 - **Do not use oven cleaners, bleach or rust removers.**
 - **Do not use gasoline or other flammable liquids or vapors to clean this or any other appliance.**
 - **Keep the appliance area clear and free from combustible materials, gasoline and other flammable vapors and liquids.**
 - **Do not obstruct the flow of combustion and ventilation air.**
- Failure to follow these guidelines could result in burns, electrical shock, fire or explosion.**

Control panel and knobs

1. Turn control knobs to the OFF position.
2. Pull control knobs straight off.
3. Use warm, soapy water or spray glass cleaner and a soft cloth to wipe the control panels. Rinse and wipe dry with a soft cloth.

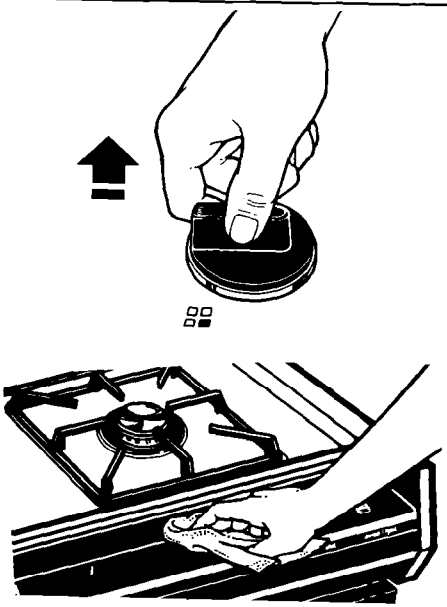

4. Wash control knobs in warm, soapy water. Rinse well and dry with a soft cloth. Do not soak.



5. Replace control knobs by pushing them firmly into place.

NOTE: When cleaning, never use steel wool, abrasives, or commercial oven cleaners which may damage the finish. After cleaning, make sure all control knobs point to the OFF position.

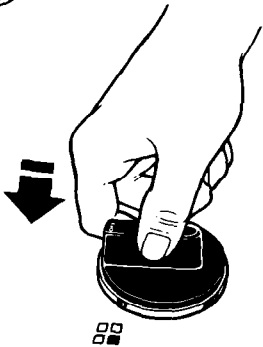

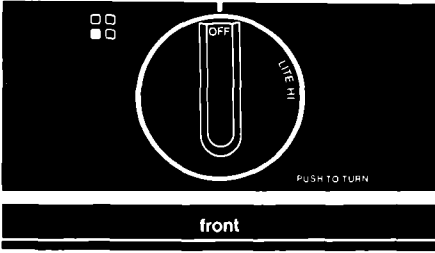

Surface burner grates and reflector pans

1. Make sure all surface burners are off and the surrounding parts are cool.

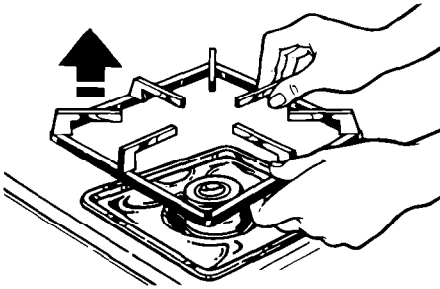

2. Lift off the burner grates and remove reflector pans.

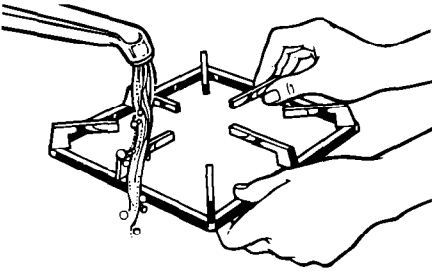

3. Wash the grates and reflector pans with warm, soapy water or in a dishwasher. Use a non-abrasive plastic scouring pad for heavily-soiled areas. Rinse and dry well.

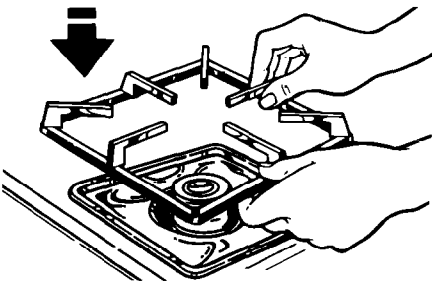

4. Replace reflector pans and burner grates.

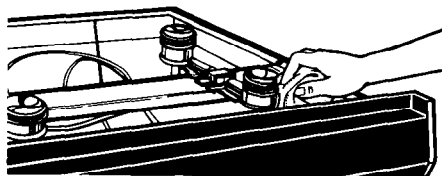

Surface burners

To remove the cooktop, follow the instructions in "Removable cooktop" below.

Wipe off surface burners with warm, soapy water and a soft cloth after each use.

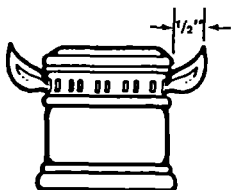

Typical surface burner flame

Occasionally check the burner flames for proper size and shape as shown below. If flames lift off ports, are yellow, or are noisy when turned off, you may need to clean the burners (see "Cleaning tips" on page 20), or call a qualified technician for adjustment.

Removable cooktop

1. Remove surface burner grates and reflector pans.

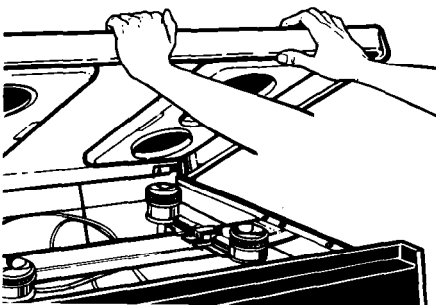
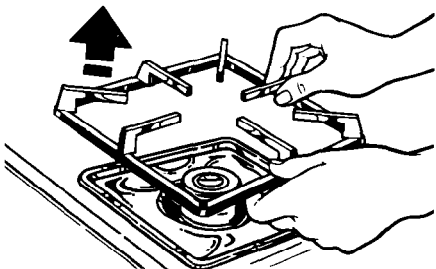

2. Lift front of cooktop enough to clear front of range. Grasp both sides of the cooktop, lift and pull forward to remove.

Caring For Your Range Continued

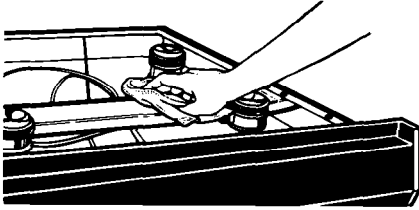

3. Wipe surface under the cooktop with warm, soapy water. Use a soap-filled plastic scrubbing pad on heavily-soiled areas.
4. Replace cooktop by fitting back of cooktop into grooves in rear brackets. Lower cooktop. Replace reflector pans and surface burner grates.

⚠ WARNING

Personal Injury and Product Damage Hazard

- Do not try to clean under the cooktop without removing it first. The cooktop could accidentally fall and injure you.
- Do not drop the cooktop. Damage can result to the porcelain and the cooktop frame.

Removable oven door

Removing the oven door will help make it easier to clean the oven.

⚠ WARNING

Burn and Electrical Shock Hazard
Make sure all controls are OFF and the oven is cool before removing oven door. Failure to do so can result in burns or electrical shock.

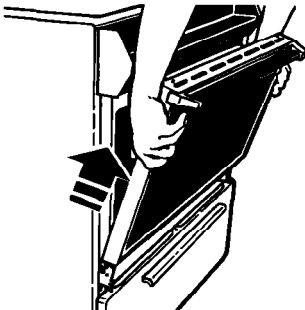

1. Open the door to the first stop position.
2. Hold the door at both sides and lift it **at the same angle it is in.**
3. **To replace,** fit the bottom corners of the door over the ends of the hinges. Push the door down evenly. The door will close only when it is on the hinges correctly.

Using the standard-cleaning oven (Model SF3100EW)

The standard oven has to be hand cleaned. Use warm soapy water, soapy steel wool pads or a commercial oven cleaner. See "Cleaning tips" on page 20 for further instructions.

⚠ CAUTION

Do not allow commercial oven cleaner to contact the heat seal, thermostat or exterior surfaces of the oven. Damage will occur.

Use foil during cooking to keep oven clean. See "Using foil" on page 19 for more information.

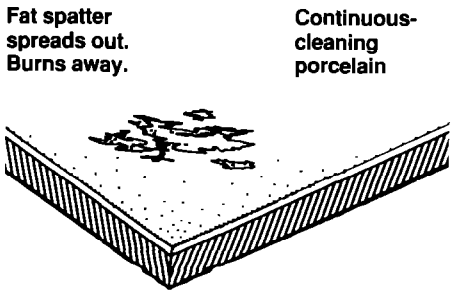
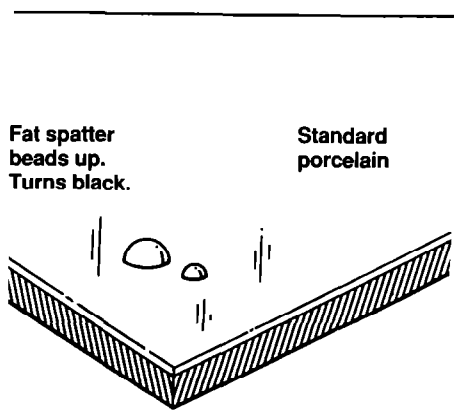

Using the continuous-cleaning oven (Models SF335PEW & SF3300EW)

Standard oven walls are coated with smooth porcelain. Your continuous-cleaning oven walls are coated with a special, rougher porcelain. A fat spatter beads up on the smooth surface, but spreads out on the rougher surface. The bead of fat on the smooth surface chars and turns black. The spread-out fat on the rough surface **gradually burns away at medium to high baking temperatures** so the oven can return to a presentably clean condition.

Caring For Your Range Continued

Cleaning tips

1. The oven window and racks are not coated. Clean them by hand.
2. The oven door does not get as hot as the walls. Some hand cleaning may be needed.
3. If you do more broiling than baking, hand cleaning may be needed.
4. Use aluminum foil or a shallow pan on the lower rack according to instructions. Spill-overs may not burn away and could stain the bottom.

Hand cleaning

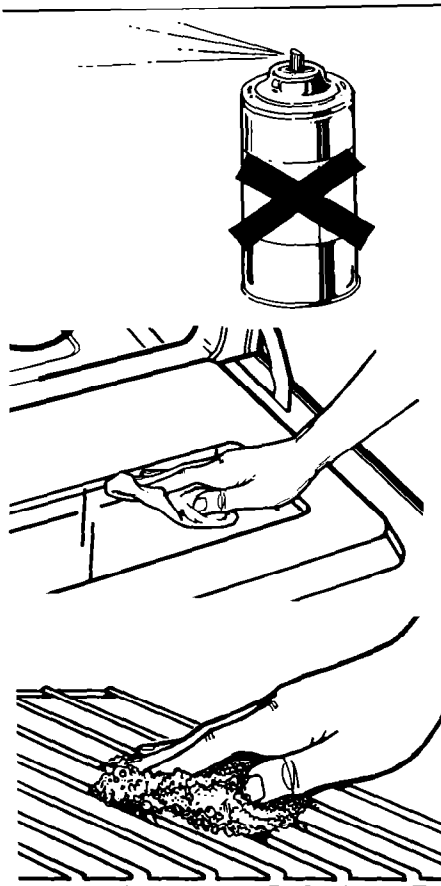

⚠ WARNING

Personal Injury Hazard

Do not use oven cleaning products in a continuous-cleaning oven. Some can become trapped in the porcelain surface and give off harmful fumes.

WINDOW – Keep clean with warm, soapy water or spray glass cleaner. Use a plastic scouring pad for heavily-soiled areas. Rinse well. **Do not use steel wool or abrasive cleansers.**

RACKS – Use a soapy steel wool pad for best cleaning results. Rinse well.

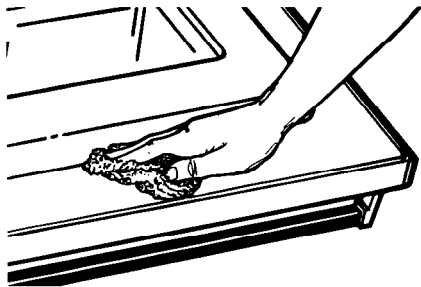

WALLS AND DOOR – Wash with warm, soapy water. Use a steel wool pad or plastic scouring pad for heavily-soiled areas. Rinse well.

Using foil (standard and continuous-cleaning ovens)

To catch sugar or starchy spills from pies and casseroles, use a piece of heavy-duty aluminum foil or a shallow pan on the lower rack, slightly larger than the cooking container.

⚠ WARNING

Burn, Electrical Shock and Product Damage Hazard

- **Make sure all controls are OFF and the oven is cool before using foil. Failure to do so can result in burns or electrical shock.**
- **Do not use foil to cover oven floor or to completely cover a rack. Good air circulation is needed for the oven to operate properly. Poor cooking results and damage to the oven could occur.**

1. Turn off all controls.
2. **Put foil or pan under the cooking container.** Make sure the foil is centered and large enough to catch any spill-overs.

Caring For Your Range Continued

Cleaning tips

Control knobs

Clean with warm, soapy water and a soft cloth.

- Wash, rinse and dry well.
- Do not soak.

Control panels

Clean with warm, soapy water or spray glass cleaner and a soft cloth.

- Wash, rinse and dry well.
- Follow directions provided with the cleaner.

Exterior surfaces (other than control panels)

Clean with warm, soapy water and a soft cloth.

- Wipe off regularly when cooktop and oven are cool.

Use a non-abrasive plastic scrubbing pad for heavily-soiled areas.

- Do not use abrasive or harsh cleaners.

NOTE: Do not allow food containing acids (such as vinegar, tomato or lemon juice) to remain on surface. Acids may remove the glossy finish. Also, wipe up milk or egg spills when cooktop is cool. Be careful when cleaning around model and serial number plate; the numbers wipe off easily.

Surface burners

Clean with warm, soapy water and a soft cloth.

- Remove cooktop (see page 15).
- Wipe off spills immediately after burner has cooled.

For cooked-on food:

- Remove burner from manifold with phillips screwdriver.
- Wash with warm, soapy water and a non-abrasive plastic scrubbing pad.
- Rinse and dry well.
- If ports are clogged, clean with a straight pin. **Do not enlarge or distort port. Do not use a wooden toothpick.**
- Do not clean surface burner in dishwasher.

Surface burner grates and chrome reflector pans

Clean with warm, soapy water and a non-abrasive plastic scrubbing pad.

- Wash, rinse and dry well.

OR

Clean in a dishwasher.

Broiler pan and grid

Clean with warm, soapy water or a soapy steel wool pad.

- Clean after each use.
- Wash, rinse and dry well.

Oven racks

Clean with warm, soapy water or soapy steel wool pads.

- Wash, rinse and dry. Use soapy steel wool pads for heavily-soiled areas.

Oven door glass

Use spray glass cleaner or warm, soapy water and a non-abrasive plastic scrubbing pad.

- Make sure oven is cool.
- Follow directions provided with the cleaner.
- Wash, rinse and dry well.

Standard oven

Clean with warm, soapy water or soapy steel wool pads.

- Make sure oven is cool.
- Remove door for easier access.
- Clean heavily-soiled areas or stains. Rinse well with water.

OR

Use commercial oven cleaners.

- Remove door for easier access.
- Place newspaper on floor to protect floor surface.
- Follow directions provided with the oven cleaner.
- Rinse well with clear water.
- Use in well-ventilated room.
- **Do not allow commercial oven cleaners to contact the heat seal, thermostat or exterior surfaces of the range. Damage will occur.**

Place piece of heavy-duty aluminum foil or shallow pan, slightly larger than the cooking container, on lower rack to catch spill-overs.

Continuous-cleaning oven

Clean with warm, soapy water or a soapy steel wool pad.

- Make sure oven is cool.
- Remove door for easier access.
- Clean heavily-soiled areas or stains. Rinse well with water.

Place piece of heavy-duty aluminum foil or shallow pan, slightly larger than the cooking container, on lower rack to catch spill-overs.

- **Do not use commercial oven cleaners.**
- **Most fat splatters on oven walls and floor will gradually reduce to a presentably clean condition during baking.**

The oven light

The oven light will come on when you push the Oven Light Switch on the control panel. Push the switch again to turn off the light.

⚠ WARNING

Electrical Shock and Personal Injury Hazard

- **Make sure oven and light bulb are cool and power to the oven has been turned off before replacing the light bulb. Failure to do so could result in electrical shock or burns.**
- **Be careful not to drop the bulb. Broken glass could cause injury.**

To replace the oven light:

1. Unplug appliance or disconnect at the main power supply.
2. Remove the light bulb from its socket. Replace with a 40-watt appliance bulb. Plug in appliance or reconnect at the main power supply.

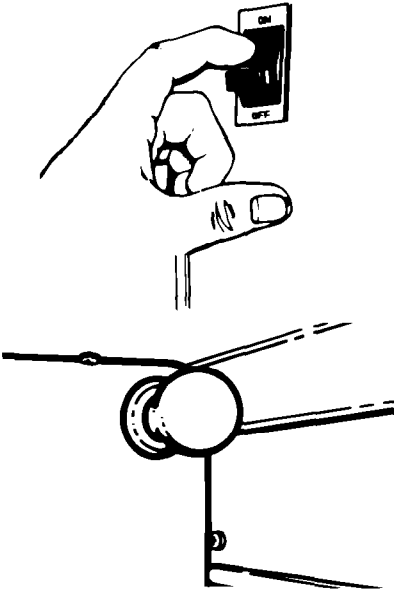

If You Need Service Or Assistance...

We suggest you follow these steps:

1. Before calling for assistance...

Performance problems often result from little things you can find and fix without tools of any kind.

If nothing operates:

- Is the gas turned on?
- Is the power supply cord plugged into a live circuit with the proper voltage? (See Installation Instructions.)
- Have you checked your home's main fuses or circuit breaker box?
- Have instructions in this book been followed?
- Is the control knob set in the correct position?
- Is the flow of combustion and/or ventilation air to the unit obstructed? **Do not obstruct airflow to and around unit.**
- Recheck suspected defect.

If burner fails to light:

- Is the range connected to electrical power?
- Have you checked your home's main fuses or circuit breaker box?
- Are burner ports clogged? See page 20.

If burner flames are uneven:

- Are burner ports clogged? See page 20.

If burner flames lift off ports, are yellow, or are noisy when turned off:

- The air/gas mixture may be incorrect. (Call for service.)

If burner makes a popping noise when ON:

- Is the burner wet from washing? Let dry.

If control knob(s) will not turn:

- Did you push in before trying to turn?

If soil is visible on continuous-cleaning oven finish:

- The special finish is designed to **gradually reduce oven soil** during normal baking or roasting. It is not designed to keep your oven spotless, only presentably clean. If you broil often, you may see oven soil. Follow hand cleaning tips on page 18.
- The door is cooler than the oven walls. Soil will be more visible on the door than other areas in the oven. See hand cleaning tips on page 18.
- Sugar and starchy spills may leave stains. See page 18 for hand cleaning tips. **Use foil on lower rack to catch these spills.**

If cooking results are not what you expected:

- Is the range level?
- Does the oven temperature seem too low or too high? See page 10.
- If needed, have you preheated the oven as the recipe calls for?
- Does the flame size fit the cooking utensil being used? (See the Cooking Guide.)
- Are you following a tested recipe from a reliable source?
- Are you using pans recommended in the Cooking Guide?
- If baking, have you allowed 1 1/2 to 2 inches (4-5 cm) on all sides of the pans for air circulation?
- Are the pans the size called for in the recipe?
- Do the cooking utensils have smooth, flat bottoms and fit the surface burners being used?

See the Cooking Guide for more information on cooking problems and how to solve them.

If You Need Service Or Assistance Continued

2. If you need assistance*...

Call Whirlpool COOL-LINE® service assistance telephone number. Dial free from anywhere in the U.S.:

1-800-253-1301

and talk with one of our trained consultants. The consultant can instruct you in how to obtain satisfactory operation from your appliance or, if service is necessary, recommend a qualified service company in your area.

If you prefer, write to:

Mr. Donald Skinner
Director of Consumer Relations
Whirlpool Corporation
2000 M-63
Benton Harbor, MI 49022

Please include a daytime phone number in your correspondence.

3. If you need service* ...



Whirlpool has a nationwide network of authorized WhirlpoolSM service companies.

Whirlpool service technicians are trained to fulfill the product warranty and provide after-warranty service, anywhere in the United States. To locate the authorized Whirlpool service company in your area, call our COOL-LINE® service assistance telephone number (see Step 2) or look in your telephone directory Yellow Pages under:

APPLIANCES - HOUSEHOLD -
MAJOR - SERVICE & REPAIR

ELECTRICAL APPLIANCES -
MAJOR - REPAIRING & PARTS

OR

WASHING MACHINES, DRYERS
& IRONERS - SERVICING

WHIRLPOOL APPLIANCES
AUTHORIZED WHIRLPOOL SERVICE

SERVICE COMPANIES
XYZ SERVICE CO
123 Maple999-9999

4. If you need FSP® replacement parts*...

FSP is a registered trademark of Whirlpool Corporation for quality parts. Look for this symbol of quality whenever you need a replacement part for your Whirlpool appliance. FSP replacement parts will fit right and work right, because they are made to the same exacting specifications used to build every new Whirlpool appliance.

To locate FSP replacement parts in your area, refer to Step 3 above or call the Whirlpool COOL-LINE service assistance number in Step 2.

5. If you are not satisfied with how the problem was solved*...

- Contact the Major Appliance Consumer Action Panel (MACAP). MACAP is a group of independent consumer experts that voices consumer views at the highest levels of the major appliance industry.
- Contact MACAP only when the dealer, authorized servicer or Whirlpool have failed to resolve your problem.

Major Appliance Consumer Action Panel
20 North Wacker Drive
Chicago, IL 60606

- MACAP will in turn inform us of your action.
- * When requesting assistance, please provide: model number, serial number, date of purchase, and a complete description of the problem. This information is needed in order to better respond to your request.

WHIRLPOOL® Gas Cooking Product Warranty

GR002

LENGTH OF WARRANTY	WHIRLPOOL WILL PAY FOR
FULL ONE-YEAR WARRANTY From Date of Purchase	FSP® replacement parts and repair labor to correct defects in materials or workmanship. Service must be provided by an authorized Whirlpool SM service company.
WHIRLPOOL WILL NOT PAY FOR	
<p>A. Service calls to:</p> <ol style="list-style-type: none"> 1. Correct the installation of the cooking product. 2. Instruct you how to use the cooking product. 3. Replace house fuses or correct house wiring or plumbing. 4. Replace owner accessible light bulbs. <p>B. Repairs when the cooking product is used in other than normal, single-family household use.</p> <p>C. Pick-up and delivery. This product is designed to be repaired in the home.</p> <p>D. Damage to the cooking product caused by accident, misuse, fire, flood, acts of God or use of products not approved by Whirlpool.</p>	

WHIRLPOOL CORPORATION SHALL NOT BE LIABLE FOR INCIDENTAL OR CONSEQUENTIAL DAMAGES. Some states do not allow the exclusion or limitation of incidental or consequential damages so this limitation or exclusion may not apply to you. This warranty gives you specific legal rights, and you may also have other rights which vary from state to state.

Outside the United States, a different warranty may apply. For details, please contact your authorized Whirlpool distributor or military exchange.

If you need service, first see the "Service and Assistance" section of this book. After checking "Service and Assistance," additional help can be found by calling our COOL-LINE® service assistance telephone number, **1-800-253-1301**, from anywhere in the U.S.

® Registered Trademark/SM Service Mark of Whirlpool Corporation